



Catalogo prodotti

EVOTECH
LIGHT & GRIP

EVOTECH progettazione

SECTION EVO



EVO DOLLY



EVO SLIM



EVO HEAD

EVOTECH progettazione

SECTION EVO



EVO LIFT



EVO VERTICAL

CRANE

EVOTECH
progettazione



MOVIE BIRD 24



JIMMY JIB

EVOTECH
progettazione

CRANE



TECHNO T24



CRANE 2M 4M

EVOTECH progettazione

CAMERA CAR



PICKUP



SMART

EVOTECH progettazione

STABILIZED HEAD



RONIN M



DJI RONIN 2



MOVIE XL

EVOTECH progettazione

STABILIZED HEAD



FORCE PRO RONIN 2



READY RIG



EASYRIG 5 VARIO CON
ESTENSIONE BRACCIO
130MM + FLOWCINE SERENE

EVOTECH progettazione

STABILIZED HEAD



TILTA ARMOR MAN 3.0



TRANQUILIZER



SHOTOVER F1

EVOTECH progettazione

SLIDER



FEMORE



ERNESTO



C – PAN ARM II

EVOTECH
progettazione

EFFECT



MACCHINA DEL FUMO



HAZE MACHINE
DJ 2000



LOW FOGMACHINE
WATERBASE LF 1500

EVOTECH progettazione

EFFECT



GIOSTRINA 8-18-50



GIOSTRINA 70/100



GIOSTRINA 2M

EVOTECH progettazione

EFFECT



FLIP ARM 1M



FLIP ARM 2M



VERTIGO

EVOTECH progettazione

EFFECT



PIOGGIA



BT HURRICANE DMX FUN

LIGHT & GRIP
noleggio attrezzature

LUCI
HMI



ARRI PAR200



ARRI M8



ARRI M18

LIGHT & GRIP noleggio attrezzature

LUCI
HMI



ARRI PAR 25-4000

LUCI
LED



SKYPANEL 120



SKYPANEL 60

LIGHT & GRIP noleggio attrezzature

LUCI
LED



GEMINI 2X1



GEMINI 1X1

LIGHT & GRIP noleggio attrezzature

LUCI
LED



ASTERA TITAN



ASTERA AX 1

LIGHT & GRIP noleggio attrezzature

LUCI
LED



ASTERA HELIOS



ASTERA BULB



APUTURE MC KIT

LIGHT & GRIP
noleggio attrezzature

LUCI
LED



APUTURE LS 1200D PRO



APUTURE 600 D PRO



APUTURE 600 C PRO RGB

LIGHT & GRIP noleggio attrezzature

LUCI
LED



APUTURE LS 300 X



APUTURE SPOTLIGHT
19°/26°/36°



APUTURE AMARAN F22C

LIGHT & GRIP
noleggio attrezzature

LUCI
LED



ASTRA 1X1



NANLUX DYNO 1200C



FLEX LED

LIGHT & GRIP noleggio attrezzature

LUCI
LED



FLEX LED 1200



TECPRO 1X1



LITE PANEL MINUS PLUS

LIGHT & GRIP
noleggio attrezzature

LUCI
NEON



KINO 4X120



KINO 4X60



DIVA 400

LIGHT & GRIP noleggio attrezzature

LUCI
NEON



BARFLY 100-200 KINO2



MINI KINO FLO



MICRO KINO FLO

LIGHT & GRIP
noleggio attrezzature

LUCI
TUNGSTENO



ARRI 12000W



STAND 10000W



ARRI 5000W



ARRI 2000W

LIGHT & GRIP
noleggio attrezzature

LUCI
TUNGSTENO



ARRI 1000W



ARRI 650W



ARRI 300W



ARRI 150W

LIGHT & GRIP noleggio attrezzature

LUCI TUNGSTENO



QUARZO 2000W



QUARZO 1000W



PHOTOFLOOD 500W

LIGHT & GRIP noleggio attrezzature

LUCI TUNGSTENO

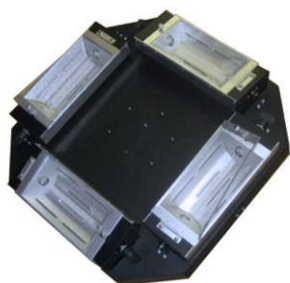

GHOST 5 KW



ETC 750W



PAR 36



MINI IRIS 1250W

LIGHT & GRIP
noleggio attrezzature

LUCI
TUNGSTENO



SUPERLUCCIOLA 75W



SOFTLIGHT 2500W



STROBO 1500W

LIGHT & GRIP noleggio attrezzature

LUCI TUNGSTENO



ACCECATORE BLINDER
4X650W

PROIETTORI



VIDEOPROIETTORE MITSUBISHI
WD 8200U

LIGHT & GRIP noleggio attrezzature

ACCESSORI LUCI
ACCESSORI VARI



SPRINGBALL LANTERNA 26"



FRESNEL F10



BARN DOORS

LIGHT & GRIP noleggio attrezzature

ACCESSORI LUCI
ACCESSORI VARI



APUTURE OCTADOME 120



APUTURE LIGHT DOME 150



ARGENTO 1X1

LIGHT & GRIP noleggio attrezzature

ACCESSORI LUCI
ACCESSORI VARI

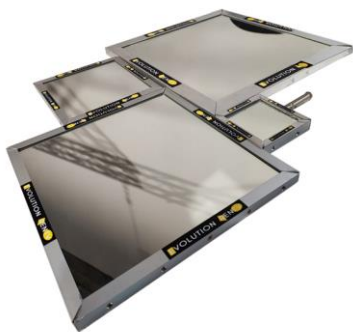

KIT SPECCHI (10X10 20X20
30X30 40X40)



CONSOLLE 6 CANALI



CONSOLLE 12 CANALI

LIGHT & GRIP noleggio attrezzature

ACCESSORI LUCI
ACCESSORI VARI



CONSOLLE ETC
COLORSOURCE 20 AV



BARRACUDA



DIMMER (1KW-2KW-5KW)

LIGHT & GRIP noleggio attrezzature

ACCESSORI LUCI
ACCESSORI VARI



DIMMER 2KW



DIMMER 3X10KW



DIMMER 6X2KW

LIGHT & GRIP noleggio attrezzature

ACCESSORI LUCI
ACCESSORI VARI



DIMMER 32A 380V 3x32A 220V



FAST FLAG KIT

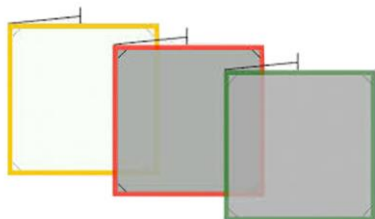

FLOPPY FLAG



INVERTER 300W-600W

LIGHT & GRIP noleggio attrezzature

ACCESSORI LUCI
ACCESSORI VARI



INVERTER 1500W



LAST O LITE



MEGA BOOM



POWER BOX 220V-380V

LIGHT & GRIP noleggio attrezzature

ACCESSORI LUCI
ACCESSORI VARI



PROLUNGHE ELETTRICHE CEE
220V-380V (16A 32A 63A 125A)



RIDUZIONE 15A-16A



RIDUZIONE 16A-15A



SDOPPIO CEE

LIGHT & GRIP noleggio attrezzature

ACCESSORI LUCI
ACCESSORI VARI

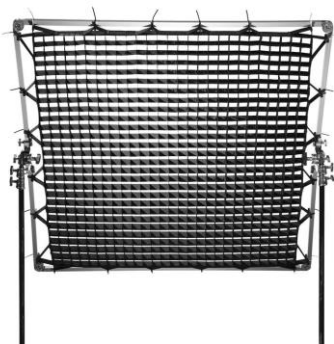

SNAP GRIP 2x2



TELAI FARFALLA (2X2 4X4 6X6)

ACCESSORI LUCI
STATIVI

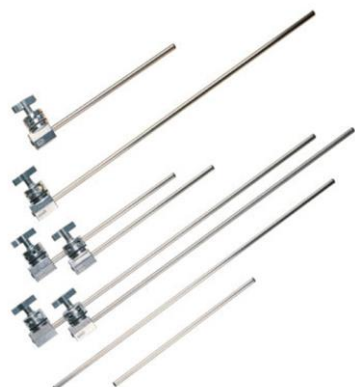

FUSTONI

LIGHT & GRIP noleggio attrezzature

ACCESSORI LUCI STATIVI



STATIVO MANFROTTO BABY



STATIVO COMPASSO



STATIVO BABY

LIGHT & GRIP noleggio attrezzature

ACCESSORI LUCI STATIVI



STATIVO PUNTALE



STATIVO BUM ARM



STATIVO WIND UP

LIGHT & GRIP noleggio attrezzature

ACCESSORI LUCI STATIVI



STATIVO SUPER WIND UP

ACCESSORI LUCI TRUSS



CINGHIE SOLLEVAMENTO



CLAMPS PER TRUSS

LIGHT & GRIP noleggio attrezzature

ACCESSORI LUCI TRUSS



GRILLI



PARANCO



SPIGOT E SPINETTE

LIGHT & GRIP noleggio attrezzature

ACCESSORI LUCI TRUSS

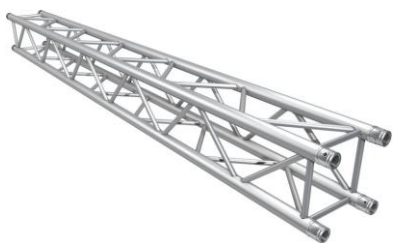

TRUSS



TRUSS 90 CORNER

LIGHT & GRIP noleggio attrezzature

GRIP



ALISCAFF CON PERNO FEMMINA



ALISCAFF CON PERNO MASCHIO



ALISCAFF CON FEMMINA 28-18

LIGHT & GRIP noleggio attrezzature

GRIP



ALISCAFF



ALISCAFF DOPPIA



SICUREZZE

LIGHT & GRIP noleggio attrezzature

GRIP



SUPER CLAMP



BARRA A TORO



CARDELLINO



CODOLI

LIGHT & GRIP

noleggio attrezzature

GRIP



FORCONE



GANCIO A C



KREMER

LIGHT & GRIP

noleggio attrezzature

GRIP



LOLLIPOP



MAGIC ARM



MORSETTI DA FALEGNAME

LIGHT & GRIP noleggio attrezzature

GRIP



PIEDI A PONTE



PINZA 1000



PINZONE 2000

LIGHT & GRIP noleggio attrezzature

GRIP



PIPA A SBALZO



RIDUZIONE A BICCHIERINO

LIGHT & GRIP noleggio attrezzature

MDP



ALEXA MINI LF



RED KOMODO 6K



BLACK MAGIC POCKET 6K
(solo body)



BLACK MAGIC POCKET 6K
COMPLETA DI ACCESSORI

LIGHT & GRIP noleggio attrezzature

MDP



SONY ILME FX3



SONY FX6



GO PRO HERO 10

LIGHT & GRIP noleggio attrezzature

ACCESSORI MDP BLACK MAGIC

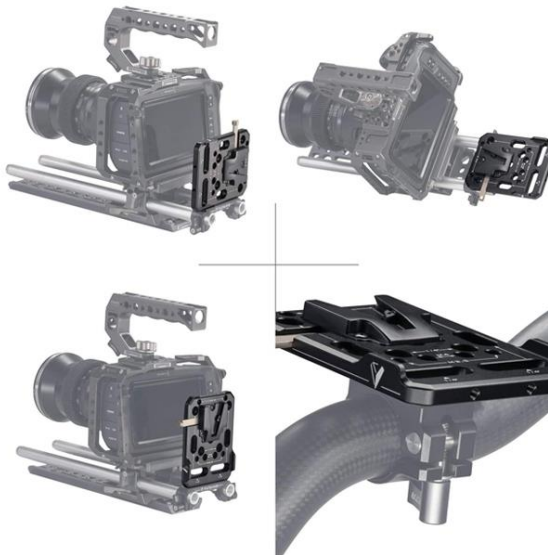

TILTA V-MOUNT BATTERY



TILTA FOLLOW FOCUS



TILTA MINI MATTE BOX

LIGHT & GRIP noleggio attrezzature

ACCESSORI MDP BLACK MAGIC



MATTEBOX TILTA 4X5,65



SAMSUNG T5



PTAP POWER CABLE



BATTERIE

LIGHT & GRIP noleggio attrezzature

ACCESSORI MDP BLACK MAGIC



LENS SUPPORT SMALL RIG



F6 PLUS 1 720X



NF F550 BATTERIE PER TILTA

LIGHT & GRIP noleggio attrezzature

ACCESSORI MDP MDP



TILTA NUCLEOS M



TILTA NUCLEOS N



TILTA FOLLOW FOCUS



MONITOR CAGE V3

LIGHT & GRIP noleggio attrezzature

ACCESSORI MDP
MDP



MAGLINER FLICART
SMARTONE XL



MAGLINER



COSMO 600

LIGHT & GRIP noleggio attrezzature

ACCESSORI MDP MDP



COSMO 1200



HOLLYLAND MARS M1 –
MONITOR 5,5



CMOTION LENS

LIGHT & GRIP noleggio attrezzature

ACCESSORI MDP MDP

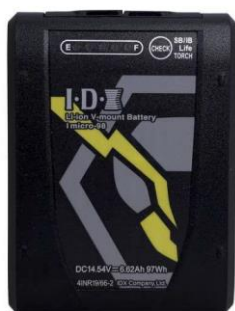

BATTERIE IMICRO- 98 IDX



CARICABATTERIE E VLOCK

LIGHT & GRIP noleggio attrezzature

ACCESSORI MDP HEAD & TRIPOD



STELLA E BAZOOKA



BAZOOKA MOVITECH CRANKED RISER



COPPE (C10-C20-FL22 NORMSBALZO)

LIGHT & GRIP noleggio attrezzature

ACCESSORI MDP HEAD & TRIPOD



HI HAT



TESTA RAGNO



TANGO SWING HEAD

LIGHT & GRIP noleggio attrezzature

ACCESSORI MDP HEAD & TRIPOD



FORMAGGIA



HEAD MANFROTTO 509HD



HEAD SACHLER VIDEO 20

LIGHT & GRIP noleggio attrezzature

ACCESSORI MDP HEAD & TRIPOD



HEAD MANFROTTO 502 AH



HEAD CARTONI C20



HEAD CARTONI MAXIMA 30

LIGHT & GRIP noleggio attrezzature

ACCESSORI MDP HEAD & TRIPOD



HEAD CARTONI KF 22



TRIPOD

LIGHT & GRIP
noleggio attrezzature

ACCESSORI MDP
MONITOR



VILTROX 7"



SEETEC 13"



SMALL HD 503U 5"

LIGHT & GRIP noleggio attrezzature

ACCESSORI MDP MONITOR



SMALL HD 17"

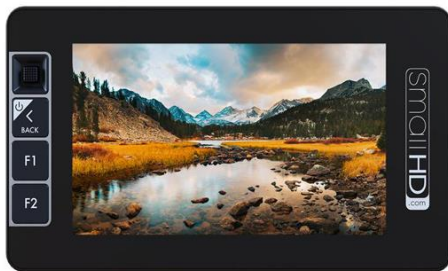

SMALL HD 7"



PANASONIC 9"

LIGHT & GRIP noleggio attrezzature

ACCESSORI MDP MONITOR



ATOMOS SHOGUN 5"/7"



MARSHALL 7"



MARSHALL 10"

LIGHT & GRIP
noleggio attrezzature

ACCESSORI MDP
MONITOR



BLACKMAGIC 15,6''



HOLLYLAND MARS M1DSLR 5,5''



ATOMOS SUMO 19''

LIGHT & GRIP
noleggio attrezzature

ACCESSORI MDP
STABILIZED HEAD



RONIN M



DJI RONIN 2



MOVI XL

LIGHT & GRIP noleggio attrezzature

ACCESSORI MDP STABILIZED HEAD



FORCE PRO RONIN 2



READY RIG



EASYRIG 5 VARIO CON
ESTENSIONE BRACCIO
130MM +FLOWCINE SERENE

LIGHT & GRIP noleggio attrezzature

ACCESSORI MDP STABILIZED HEAD



TILTA ARMOR MAN 3.0



SHOTOVER F1



TRANQUILIZER

LIGHT & GRIP
noleggio attrezzature

ACCESSORI MDP
OTTICHE



LENS KIT DZO FILM VESPID
(25-35-50-75-100-125)



DZO FILM PICTOR 20-55 mm
T2 8 BLACK



DZO FILM PICTOR 50-125 mm
T2 8 BLACK



LAOWA 12MM T2,9 EF ZERO - D

LIGHT & GRIP
noleggio attrezzature

ACCESSORI MDP
OTTICHE



VENUS LAOWA 24mm F14
2x MACRO 1200PX PROBE LENS



SAMYANG 8mm CS II



CINE 7 ARTISAN SPECTRUM
35-50-85



ZOOM SONY FE 2,8 24-70mm GM

LIGHT & GRIP noleggio attrezzature

ACCESSORI MDP
ACCESSORI OTTICHE



METABONES MB EF E BT5



ADATTATORE SIRUI DA PL A
RF-MOUNT



ADATTATORE VOCAS DA E A
PL-MOUNT

LIGHT & GRIP noleggio attrezzature

ACCESSORI MDP
ACCESSORI OTTICHE



KIT FILTRI TIFFEN 4X5,65 ND
3_6_9_1/2_1/5_1/8

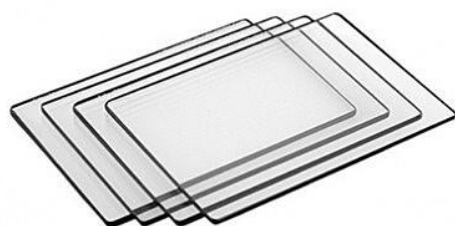

BLACK PRO MIST 4X5,65
1/8_1/4_1/2

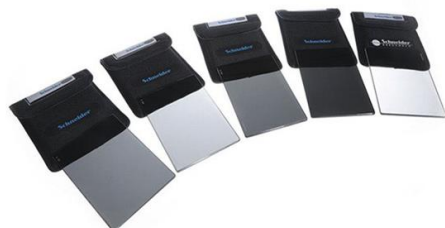

FILTRI SHNEIDER HOLLYWOOD
BLACK MAGIC 4X5,65
1_1/2_1/4

LIGHT & GRIP noleggio attrezzature

ACCESSORI MDP ACCESSORI OTTICHE



FILTRO CLEAR



FILTRO ROTA POLA

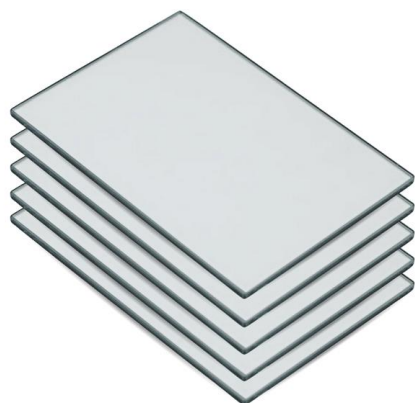

KIT FILTRI GLIMMERGLASS
4X5,65 (1,1/2, 1/4, 1/8, 2)

LIGHT & GRIP
noleggio attrezzature

ACCESSORI MDP
ACCESSORI OTTICHE



KIT FILTRITIFFEN 138MM
CLOSE UP DIOPTER
(+1, +1/2, +2)

LIGHT & GRIP
noleggio attrezzature

ACCESSORI MDP
VARI



SNORRICAM



HELMET POV



GINEVRA

LIGHT & GRIP
noleggio attrezzature

ACCESSORI MDP
VARI



SPALLACCIO TILTA SHOULDER RIG



STEADY BAG



SADDLE CAM

ACCESSORI MDP
VARI

LIGHT & GRIP
noleggio attrezzature



MANINA MANFROTTO

LIGHT & GRIP

noleggio attrezzature

FACILITIES



SOLIDCOM C1 PRO 8S



WALKY TALKY



VENTILATORE

LIGHT & GRIP
noleggio attrezzature

FACILITIES



TAVOLO



VALIGIA MAKE UP CON SPECCHIO



SPECCHIO PER MAKE UP

LIGHT & GRIP
noleggio attrezzature

FACILITIES



SCALA SFILO



SCALA LIBRO



SEDIA

LIGHT & GRIP noleggio attrezzature

FACILITIES



SEDIA REGISTA



STEAMER



PALLA A SPECCHIO

FACILITIES

LIGHT & GRIP
noleggio attrezzature



PALANCA



MODULO PALCO



CARRELLO SPOSTA AUTO
(KIT 4 PEZZI)

LIGHT & GRIP
noleggio attrezzature

FACILITIES

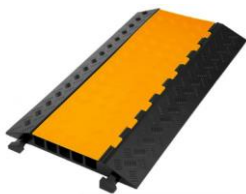

PASSACAVO



CONO DISSUASORE



OMBRELLONE QUADRO



OMBRELLONE

FACILITIES

LIGHT & GRIP noleggio attrezzature



MEGAFONO



LAVAZZA ESPRESSO POINT AL
3200 310



GRUPPO ELETTOGENO
HONDA EU 20I

LIGHT & GRIP
noleggio attrezzature

FACILITIES



TANICA



INFRAROSSI



GAZEBO 6X3

FACILITIES

LIGHT & GRIP noleggio attrezzature



GAZEBO 2X2



TAPIS ROULANT



TAPPETO ELASTICO

LIGHT & GRIP
noleggio attrezzature

MACCHINISMO

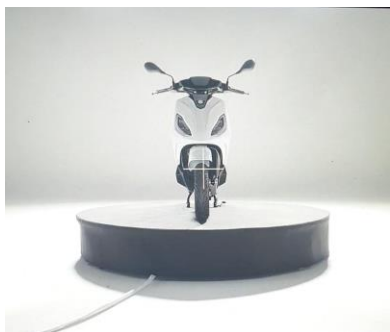

GIOSTRINA 2M



GIOSTRINA 70/100



GIOSTRINA 8-18-70

MACCHINISMO

LIGHT & GRIP
noleggio attrezzature



FLIP ARM 1M



FLIP ARM 2M

LIGHT & GRIP noleggio attrezzature

MACCHINISMO



VENTOSA



VENTOSA CON MANOMETRO



SEDIOLA



MULTIMOUNT

MACCHINISMO

LIGHT & GRIP
noleggio attrezzature



PIATTINA (40-80)



U-BANJI



SLIDER

LIGHT & GRIP
noleggio attrezzature

MACCHINISMO



SNORRICAM



HELMET POV



PEWEE

LIGHT & GRIP
noleggio attrezzature

MACCHINISMO



MACCHINA DEL FUMO



HAZE MACHINE DJ 2000



**LOW FOGMACHINE WATERBASE –
LF 1500**

MACCHINISMO

LIGHT & GRIP
noleggio attrezzature



BT HURRICANE DMX FUN

CONDIZIONI GENERALI DI NOLEGGIO

Il cliente (conduttore), con l'atto della firma dell'allegata bolla di accompagnamento (DDT), anche se il ritiro avviene a mezzo Terzi, dichiara di accettare integralmente ed incondizionatamente quanto espressamente di seguito stabilito:

ART. 1 OGGETTO - Il materiale dato a noleggio è di esclusiva proprietà della EVOLUTION RENTV Srl.

Il materiale corrisponde nella qualità e quantità a quanto elencato ed in perfetto stato d'uso e funzionamento.

Il Cliente si intende fin d'ora custode e per tale ragione è tenuto a conservarlo con cura e a dichiararne la proprietà ad eventuali tentativi di pignoramento o sequestro, a qualsiasi titolo ed in qualsiasi luogo.

Il materiale dato a noleggio dalla EVOLUTION RENTV Srl è approntato secondo le norme vigenti ed il Cliente che provvederà all'installazione ed allacciamenti, anche a mezzo terzi, dovrà osservare scrupolosamente le norme di sicurezza, assumendosi ogni totale responsabilità di ordine penale, civile e fiscale.

In caso di guasto del materiale in corso di noleggio, la EVOLUTION RENTV Srl provvederà alla restituzione dell'articolo con altro funzionante solo se disponibile in magazzino, riservandosi di addebitare la spesa di riparazione quando sia dovuta per trascuratezza, sinistro, o comunque cause imputabili al Cliente o terzi. La sostituzione avverrà a spese e cura del Cliente presso la sede della EVOLUTION RENTV Srl, la quale non potrà essere ritenuta responsabile, in alcun modo, del cattivo funzionamento del materiale a seguito del quale venga ritardata o compromessa l'operazione.

ART. 2 CONSEGNA - Il materiale viene consegnato a cura, spese e rischi del cliente.

ART. 3 RESTITUZIONE - Il conduttore deve restituire il materiale nel medesimo stato in cui lo ha ricevuto, nelle condizioni e modi di cui all'art.2 all'indirizzo della EVOLUTION RENTV Srl, durante gli orari di apertura del magazzino (sabato chiuso). Il Cliente è tenuto a comunicare la data della probabile restituzione ed ogni eventuale variazione.

ART. 4 MATERIALE MANCANTE E/O DANNEGGIATO - Il Cliente, o chi per esso, assisterà di norma al controllo del materiale reso. In questa occasione il materiale mancante, anche in parte, o danneggiato (comprese le lampade bruciate), verranno addebitati al Cliente al prezzo corrente. In caso di restituzione successiva del materiale addebitato la EVOLUTION RENTV Srl rimborserà quanto precedentemente fatturato, agli stessi prezzi.

Per il materiale danneggiato, il conduttore dovrà corrispondere un'indennità equivalente al prezzo di noleggio per la durata dei lavori di riparazione.

Non si accettano riconsegne parziali di pezzi di uno stesso apparecchio; i giorni di noleggio saranno calcolati fino al ritorno integrale e completo del materiale.

ART. 5 DURATA - Il periodo di noleggio, salvo accordi particolari, è dato in giorni, dalla differenza aritmetica risultante dalla data di restituzione e quella del ritiro. Il materiale può essere ritirato nel pomeriggio e reso in mattinata entro le ore 10. In caso contrario si darà luogo all'addebito della giornata stessa. Il periodo minimo di noleggio è di 1 giorno. Ogni ritardo nella riconsegna del materiale è considerato prolungamento del noleggio stesso.

ART. 6 ASSICURAZIONE - Il materiale dato a noleggio dalla EVOLUTION RENTV Srl quando si trova all'esterno dei ns. magazzini NON E' ASSICURATO contro furto e danni di qualsiasi natura. In caso di furto, incendio, perdita del materiale, il Cliente dovrà informare la EVOLUTION RENTV Srl entro 24 ore a mezzo raccomandata AR o mail pec, fermo restando il diritto della stessa di richiedere il rimborso integrale e immediato

ART. 7 CONTESTAZIONI - Eventuali contestazioni devono, pena decadenza, essere denunciate entro e non oltre il termine della produzione, e possibilmente al momento del ritiro o della consegna del materiale alla location concordata. Ogni contestazione denunciata successivamente all'invio del consuntivo non potrà essere ritenuta valida e nessuna responsabilità o danno potrà essere addebitato a EVOLUTION RENTV Srl.

ART. 8 PREZZI - I prezzi si intendono quelli indicati nel listino conteggiati al giorno, iva esclusa.

Le gelatine e i materiali a consumo verranno fatturati al prezzo di listino in vigore.

ART. 9 PAGAMENTI - I pagamenti concordati, come indicato in fattura, dovranno essere tassativamente rispettati.

ART. 10 FORO COMPETENTE - Il Foro competente è esclusivamente quello di MILANO.

Novate Milanese
EVOLUTION RENTV SRL